

Scheda Tecnica

CODICE 61137

NORDIK HVLS SUPER BLADE 700/280" T

Ventilatori da soffitto industriali



Certificazioni

Dati tecnici e prestazionali

Corrente nominale (A)	1,35	Potenza assorbita max (W)	900
Diametro nominale (m)	7	Temp. ambiente max funzionamento continuativo (°C)	50
Frequenza (Hz)	50-60	Tensione (V)	200-480
Grado Protezione IP	65	Portata max (m³/h)	650.000
Numero pale	5	Pressione Sonora Lp [dB (A)] in campo libero- 5m	<45
Peso (Kg)	129	RPM max	38

Dimensioni

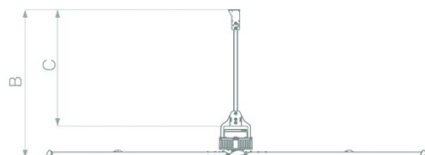

Diametro A (mm)	Ø7000
Dimensione B (mm)	1880
Dimensione C (mm)	1470

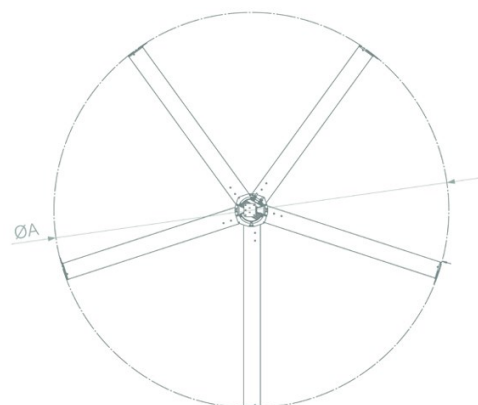

PER INFORMAZIONI / FOR INFORMATION

ITALY

Pre Sales:
prevendita@vortice-italy.com
After Sales:
postvendita@vortice-italy.com

UNITED KINGDOM & REP. OF IRELAND

Sales Dept:
sales@vortice.ltd.uk
Technical Dept:
technical@vortice.ltd.uk

OTHER COUNTRIES

Sales Dept:
export@vortice-italy.com
After Sales:
after-sales@vortice-italy.com

Scheda Tecnica

CODICE 61137

NORDIK HVLS SUPER BLADE 700/280" T

Ventilatori da soffitto industriali



Descrizione

Accessori



POT-I

Codice 12832



POT

Codice 12828



VORT T

Codice 21137

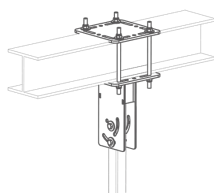

STF1

Codice 20267

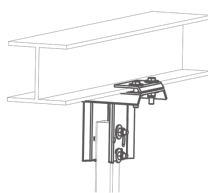

STF2

Codice 20268

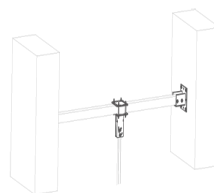

STF3

Codice 20269

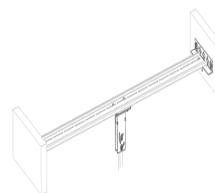

STF4

Codice 20270

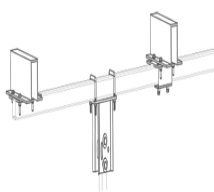

STF5

Codice 20271

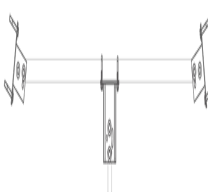

STF6

Codice 20272



HVLS HYPERBLADE- RD

Codice 20193



WP

Codice 21197



USB-C

Codice 21198

PER INFORMAZIONI / FOR INFORMATION

ITALY

Pre Sales:

prevendita@vortice-italy.com

After Sales:

postvendita@vortice-italy.com

UNITED KINGDOM & REP. OF

IRELAND

Sales Dept:

sales@vortice.ltd.uk

Technical Dept:

technical@vortice.ltd.uk

OTHER COUNTRIES

Sales Dept:

export@vortice-italy.com

After Sales:

after-sales@vortice-italy.com