

## Scheda Tecnica

CODICE 61136

### NORDIK HVLS SUPER BLADE 600/240" T

Ventilatori da soffitto industriali



## Certificazioni

## Dati tecnici e prestazionali

Corrente nominale (A)	2,69	Potenza assorbita max (W)	1100
Diametro nominale (m)	6	Temp. ambiente max funzionamento continuo (°C)	50
Frequenza (Hz)	50-60	Tensione (V)	200-480
Grado Protezione IP	65	Portata max (m³/h)	600.000
Numero pale	5	Pressione Sonora Lp [dB (A)] in campo libero- 5m	<45
Peso (Kg)	121	RPM max	65

## Dimensioni

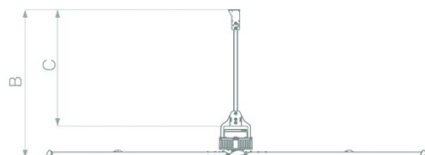

Diametro A (mm)	Ø6000
Dimensione B (mm)	1880
Dimensione C (mm)	1470

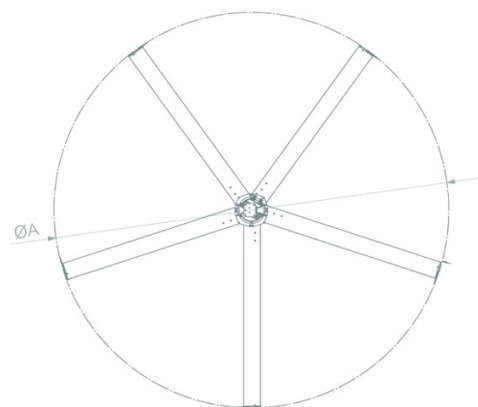

### PER INFORMAZIONI / FOR INFORMATION

#### ITALY

Pre Sales:  
prevendita@vortice-italy.com  
After Sales:  
postvendita@vortice-italy.com

#### UNITED KINGDOM & REP. OF IRELAND

Sales Dept:  
sales@vortice.ltd.uk  
Technical Dept:  
technical@vortice.ltd.uk

#### OTHER COUNTRIES

Sales Dept:  
export@vortice-italy.com  
After Sales:  
after-sales@vortice-italy.com

# Scheda Tecnica

CODICE 61136

## NORDIK HVLS SUPER BLADE 600/240" T

Ventilatori da soffitto industriali



## Descrizione

### Accessori

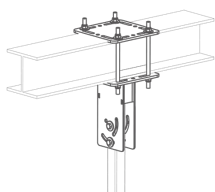

#### STF1

Codice 20267

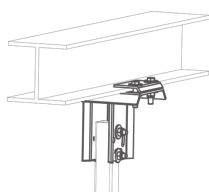

#### STF2

Codice 20268

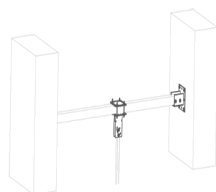

#### STF3

Codice 20269

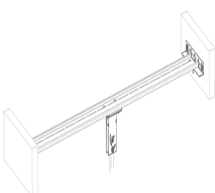

#### STF4

Codice 20270

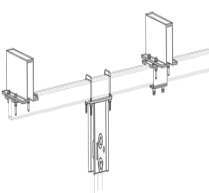

#### STF5

Codice 20271

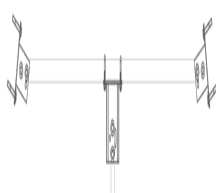

#### STF6

Codice 20272



#### HVLS HYPERBLADE- RD

Codice 20193



#### WP

Codice 21197



#### USB-C

Codice 21198



#### POT

Codice 12828



#### POT-I

Codice 12832



#### VORT T

Codice 21137

PER INFORMAZIONI / FOR INFORMATION

ITALY

Pre Sales:

[prevendita@vortice-italy.com](mailto:prevendita@vortice-italy.com)

After Sales:

[postvendita@vortice-italy.com](mailto:postvendita@vortice-italy.com)

UNITED KINGDOM & REP. OF

IRELAND

Sales Dept:

[sales@vortice.ltd.uk](mailto:sales@vortice.ltd.uk)

Technical Dept:

[technical@vortice.ltd.uk](mailto:technical@vortice.ltd.uk)

OTHER COUNTRIES

Sales Dept:

[export@vortice-italy.com](mailto:export@vortice-italy.com)

After Sales:

[after-sales@vortice-italy.com](mailto:after-sales@vortice-italy.com)