

## Scheda Tecnica

CODICE 61135

### NORDIK HVLS SUPER BLADE 500/200" T L

Ventilatori da soffitto industriali



## Certificazioni

## Dati tecnici e prestazionali

Corrente nominale (A)	1,97	Potenza assorbita max (W)	850
Diametro nominale (m)	5	Temp. ambiente max funzionamento continuativo (°C)	50
Frequenza (Hz)	50-60	Tensione (V)	200-480
Grado Protezione IP	65	Portata max (m³/h)	530.000
Numero pale	5	Pressione Sonora Lp [dB (A)] in campo libero- 5m	<45
Peso (Kg)	113	RPM max	80

## Dimensioni

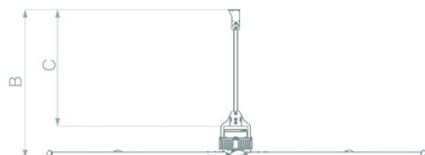

Diametro A (mm)	Ø5000
Dimensione B (mm)	3310
Dimensione C (mm)	3000

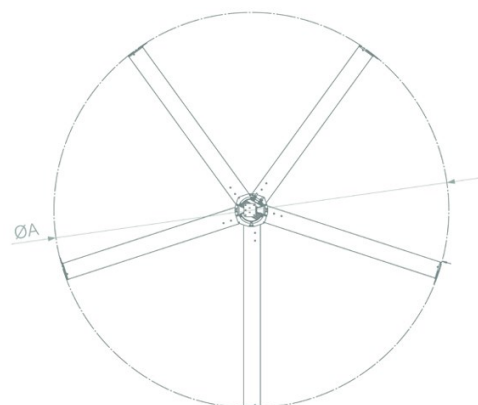

### PER INFORMAZIONI / FOR INFORMATION

#### ITALY

Pre Sales:  
prevendita@vortice-italy.com  
After Sales:  
postvendita@vortice-italy.com

#### UNITED KINGDOM & REP. OF IRELAND

Sales Dept:  
sales@vortice.ltd.uk  
Technical Dept:  
technical@vortice.ltd.uk

#### OTHER COUNTRIES

Sales Dept:  
export@vortice-italy.com  
After Sales:  
after-sales@vortice-italy.com



## Descrizione

### Accessori

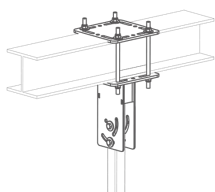

**STF1**

Codice 20267

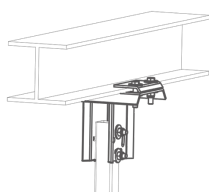

**STF2**

Codice 20268

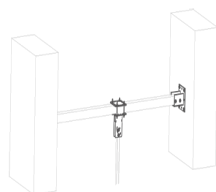

**STF3**

Codice 20269

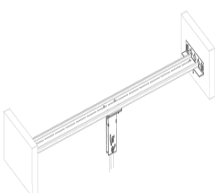

**STF4**

Codice 20270

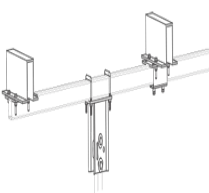

**STF5**

Codice 20271

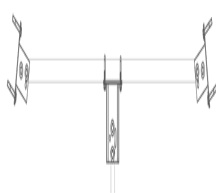

**STF6**

Codice 20272



**HVLS  
HYPERBLADE-  
RD**

Codice 20193



**WP**

Codice 21197



**USB-C**

Codice 21198



**POT**

Codice 12828



**VORT T**

Codice 21137



**POT-I**

Codice 12832

PER INFORMAZIONI / FOR INFORMATION

ITALY

Pre Sales:

[prevendita@vortice-italy.com](mailto:prevendita@vortice-italy.com)

After Sales:

[postvendita@vortice-italy.com](mailto:postvendita@vortice-italy.com)

UNITED KINGDOM & REP. OF

IRELAND

Sales Dept:

[sales@vortice.ltd.uk](mailto:sales@vortice.ltd.uk)

Technical Dept:

[technical@vortice.ltd.uk](mailto:technical@vortice.ltd.uk)

OTHER COUNTRIES

Sales Dept:

[export@vortice-italy.com](mailto:export@vortice-italy.com)

After Sales:

[after-sales@vortice-italy.com](mailto:after-sales@vortice-italy.com)