

## Scheda Tecnica

CODICE 61131

### NORDIK HVLS SUPER BLADE 300/120" M L

Ventilatori da soffitto industriali



## Certificazioni

## Dati tecnici e prestazionali

Corrente nominale (A)	1,98	Temp. ambiente max funzionamento continuo (°C)	50
Diametro nominale (m)	3	Tensione (V)	85-264
Numero pale	5	Portata max (m³/h)	270.000
Peso (Kg)	70	Pressione Sonora Lp [dB (A)] in campo libero- 5m	<60
Potenza assorbita max (W)	405	RPM max	140
		RPM min	10

## Dimensioni

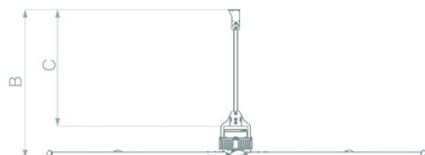

Diametro A (mm)	Ø3000
Dimensione B (mm)	3310
Dimensione C (mm)	3000

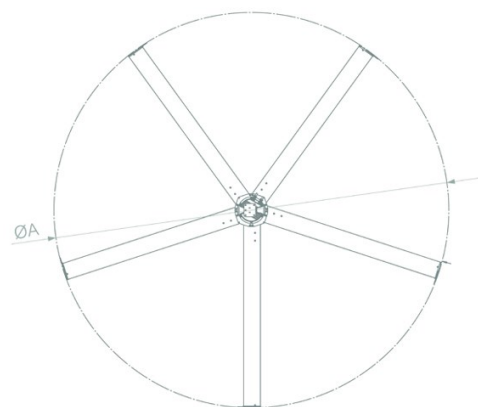

### PER INFORMAZIONI / FOR INFORMATION

#### ITALY

Pre Sales:  
prevendita@vortice-italy.com  
After Sales:  
postvendita@vortice-italy.com

#### UNITED KINGDOM & REP. OF IRELAND

Sales Dept:  
sales@vortice.ltd.uk  
Technical Dept:  
technical@vortice.ltd.uk

#### OTHER COUNTRIES

Sales Dept:  
export@vortice-italy.com  
After Sales:  
after-sales@vortice-italy.com

# Scheda Tecnica

CODICE 61131

## NORDIK HVLS SUPER BLADE 300/120" M L

Ventilatori da soffitto industriali



## Descrizione

## Accessori



### WP

Codice 21197



### USB-C

Codice 21198

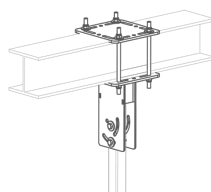

### STF1

Codice 20267

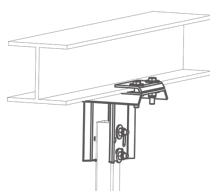

### STF2

Codice 20268

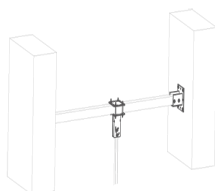

### STF3

Codice 20269

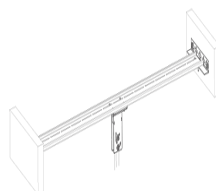

### STF4

Codice 20270

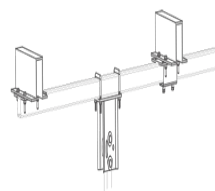

### STF5

Codice 20271

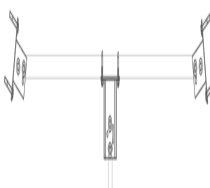

### STF6

Codice 20272



### HVLS HYPERBLADE- RD

Codice 20193



### POT

Codice 12828



### POT-I

Codice 12832



### VORT T

Codice 21137

PER INFORMAZIONI / FOR INFORMATION

ITALY

Pre Sales:

[prevendita@vortice-italy.com](mailto:prevendita@vortice-italy.com)

After Sales:

[postvendita@vortice-italy.com](mailto:postvendita@vortice-italy.com)

UNITED KINGDOM & REP. OF

IRELAND

Sales Dept:

[sales@vortice.ltd.uk](mailto:sales@vortice.ltd.uk)

Technical Dept:

[technical@vortice.ltd.uk](mailto:technical@vortice.ltd.uk)

OTHER COUNTRIES

Sales Dept:

[export@vortice-italy.com](mailto:export@vortice-italy.com)

After Sales:

[after-sales@vortice-italy.com](mailto:after-sales@vortice-italy.com)