



# IVR 327

Valvola di controllo indipendente dalla pressione (PICV) in ottone DZR  
Filettata M/M per bocchettone (ISO228/1)

Con gruppo di regolazione per  $\Delta P$  fino a 400kPa

Tolleranza sulla portata nominale regolata  $\pm 15\%$

Disponibile nelle versioni:

- senza prese pressione  
(non ne permette il successivo montaggio)

- con prese pressione

Modulazione portata lungo tutta la corsa dell'attuatore

(indipendentemente dalla preregolazione)

Con connessione filettata M30x1,5 per attuatore lineare

Conforme TR CU 010

PN20 (Max 20bar fino a 100°C, max 10bar a 130°C)

Esente marcatura CE (cat. secondo Art. 4.3 Dir. 2014/68/UE)

Condizioni di esercizio

- Acqua: da -10°C a +130°C  
sotto 0°C solo per acqua additivata con antigelo  
oltre 100°C solo con additivi che prevengano l'ebollizione  
(utilizzabili miscele di glicole etilenico o glicole propilenico fino al 50%)
- Non idoneo per: gas gruppo 1 e 2, liquidi gruppo 1 (Dir.2014/68/UE)

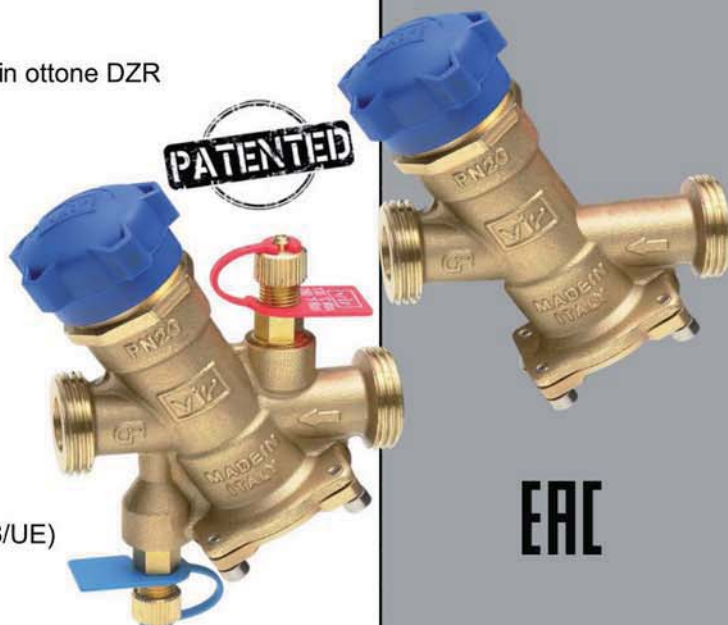

EAC

## PARTLIST

N.	Componente	Materiale	Norma
1	Viti a brugola	Acciaio inox	AISI 304
2	Tappo	Ottone DZR	EN12164 CW602N
3	Cursore <sup>1</sup>	Acciaio inox	AISI 303
4	Molla	Acciaio inox	AISI 302
5	Sede cursore	Ottone DZR	EN12164 CW602N
6	O-ring sede/corpo	EPDM Perox	-
7	O-ring sede/curs.	EPDM Perox	-
8	Corpo	Ottone DZR	EN12165 CW602N
9	Rondella	Ottone DZR	EN12164 CW602N
10	Disco guarn.	EPDM Perox	-
11	Gruppo reg. port.	Ottone DZR <sup>2</sup>	EN12164 CW602N
12	O-ring	EPDM Perox	-
13	Molla	Acciaio inox	AISI 302
14	Scala di reg.	Poliammide	-
15	Volantino ON/OFF	Poliammide	-
16	Presca	Ottone DZR <sup>3</sup>	EN12164 CW602N

<sup>1</sup>In due pezzi, con diaframma in EPDM Perox

<sup>2</sup>Con molla in acciaio inox (AISI 302) e guarnizioni in EPDM Perox

<sup>3</sup>Prese pressione con guarnizioni in EPDM e cravatte in polipropilene

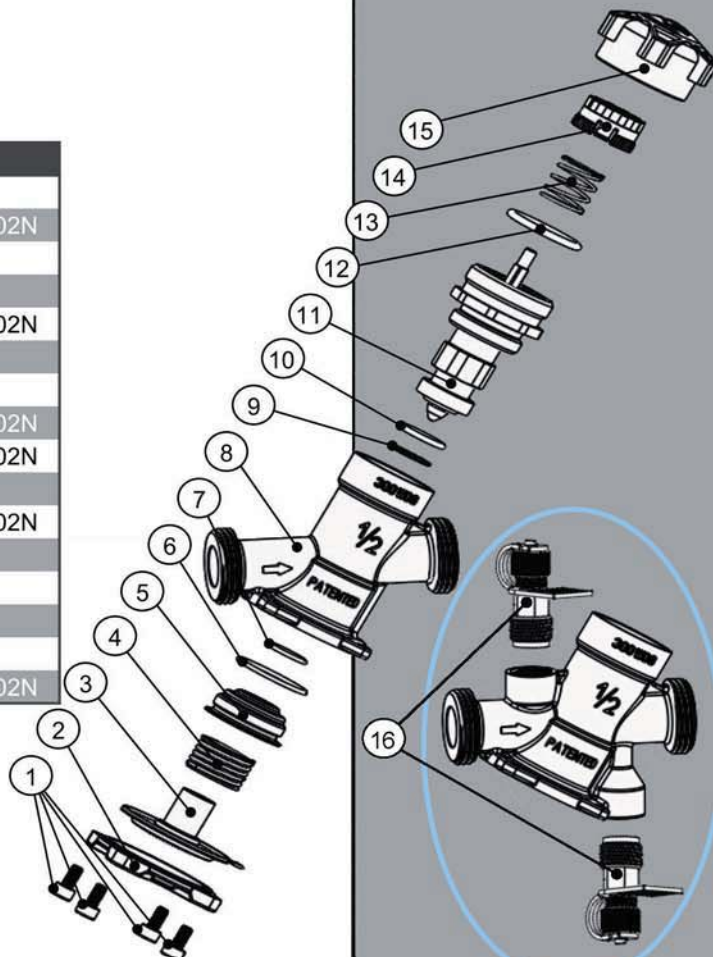

# DIMENSIONI

DN	G	L [mm]	HA [mm]	HP [mm]	HB [mm]	W [mm]	ØV [mm]	Peso <sup>1</sup> [g]	Portate [l/s]
L 015	¾"	78,6	38,9	60,9	62,1	43,0	40	380/420	0,008-0,039
015	¾"	78,6	38,9	60,9	62,1	43,0	40	380/420	0,030-0,150
020	1"	92,0	47,4	69,4	62,0	52,0	40	570/600	0,062-0,311
025	1¼"	115,0	56,2	78,2	75,3	59,4	40	1100/1130	0,120-0,600
032	1½"	140,0	78,0	91,6	76,0	81,5	40	1960/2015	0,200-1,000

<sup>1</sup>Versione senza prese / versione con prese

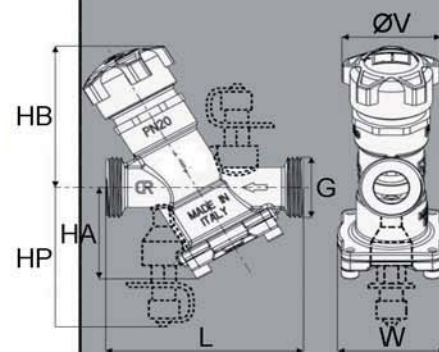

# PREREGOLAZIONE

La prerogolazione permette di impostare la portata massima della valvola, ovvero la portata che verrà mantenuta costante entro il range di pressione differenziale di utilizzo (secondo i principi del bilanciamento dinamico) a valvola completamente aperta.

La prerogolazione influisce sulla pressione differenziale minima di utilizzo della valvola.

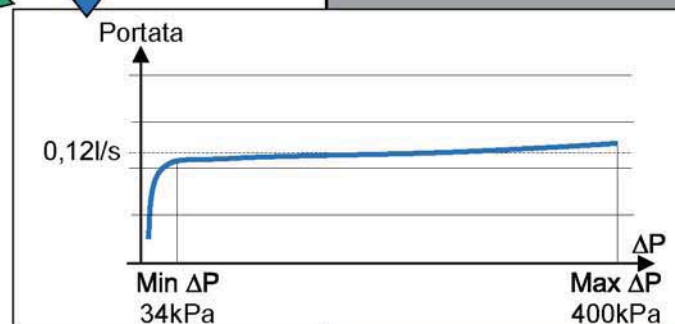
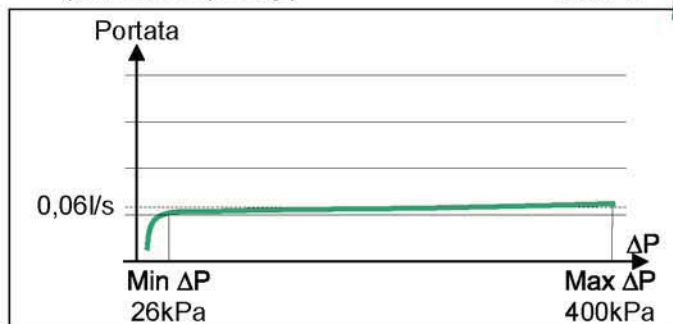
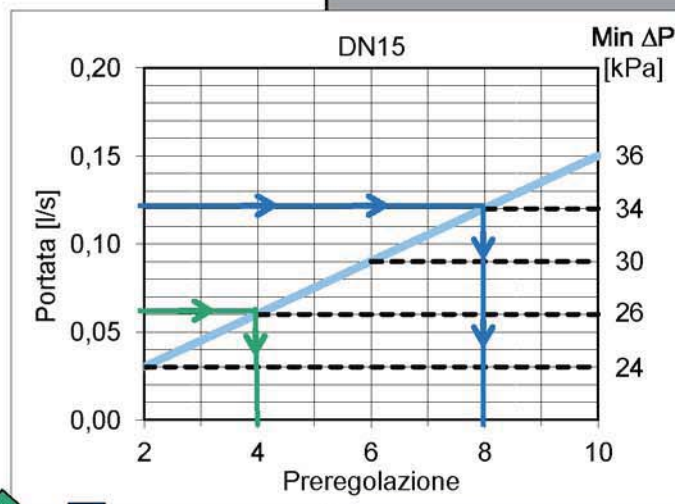
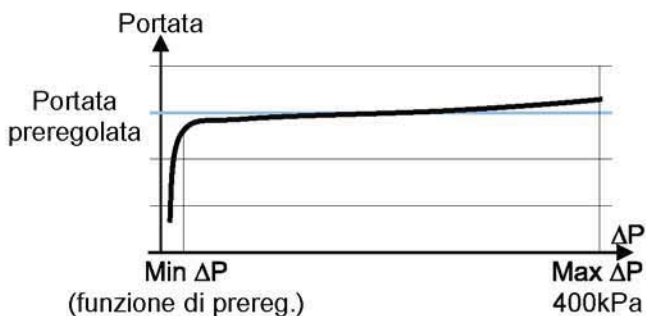

Il gruppo di regolazione conserva capacità di controllo della portata su tutta la corsa assiale indipendentemente dalla prerogolazione (full stroke modulation). Utilizzando un attuatore modulante si mantiene quindi proporzionalità tra il segnale di controllo e la portata effettiva regolata dalla valvola.

Nell'esempio per una portata massima di 0,12l/s risulta per una valvola DN15 una prerogolazione di 8. La  $\Delta P$  minima di funzionamento sarà 34kPa. Tale portata é quindi modulata con un attuatore IVR con segnale 0-10V impostato su "azione inversa". E' comunque possibile impostare l'attuatore su "azione diretta" invertendo così la corrispondenza tra segnale e portate (fare riferimento alla scheda tecnica dell'attuatore).

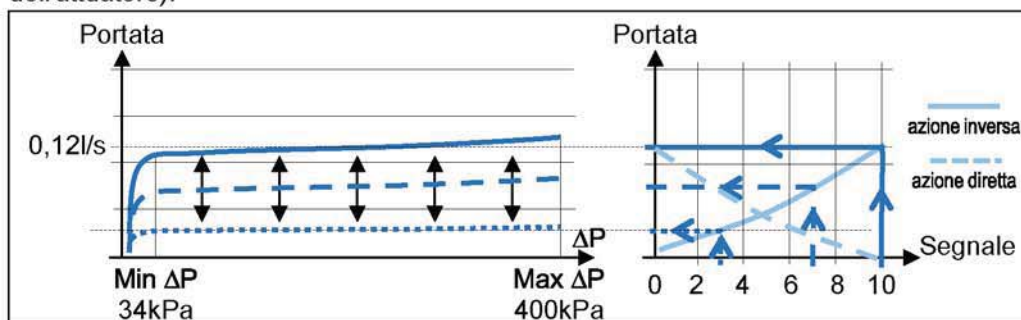



E' possibile impostare la prerogolazione sulla valvola utilizzando direttamente la scala di prerogolazione, senza bisogno di ulteriori strumenti:

- premere la scala di regolazione verso il basso
- ruotare la scala facendo corrispondere il valore desiderato alla tacca sul vitone
- rilasciare la scala di regolazione che andrà a bloccarsi nella posizione impostata

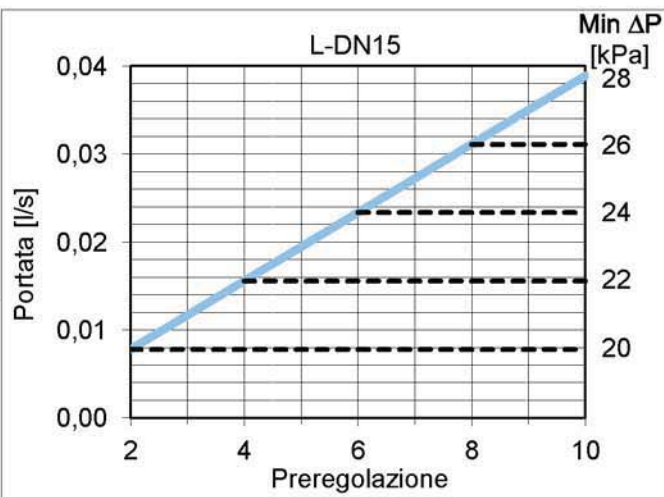

L-DN15 Prereg.	Portata [l/s]	Portata [l/h]	ΔP min. [kPa]
2	0,008	28	20
3	0,012	42	21
4	0,016	56	22
5	0,019	70	23
6	0,023	84	24
7	0,027	98	25
8	0,031	112	26
9	0,035	126	27
10	0,039	140	28

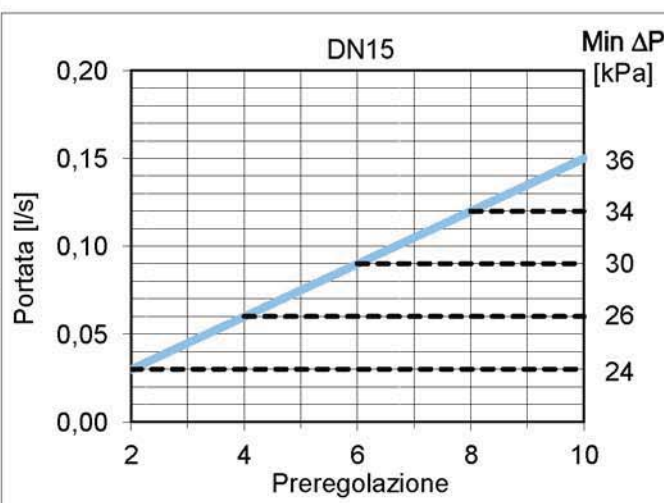

DN15 Prereg.	Portata [l/s]	Portata [l/h]	ΔP min. [kPa]
2	0,030	108	24
3	0,045	162	25
4	0,060	216	26
5	0,075	270	28
6	0,090	324	30
7	0,105	378	32
8	0,120	432	34
9	0,135	486	35
10	0,150	540	36

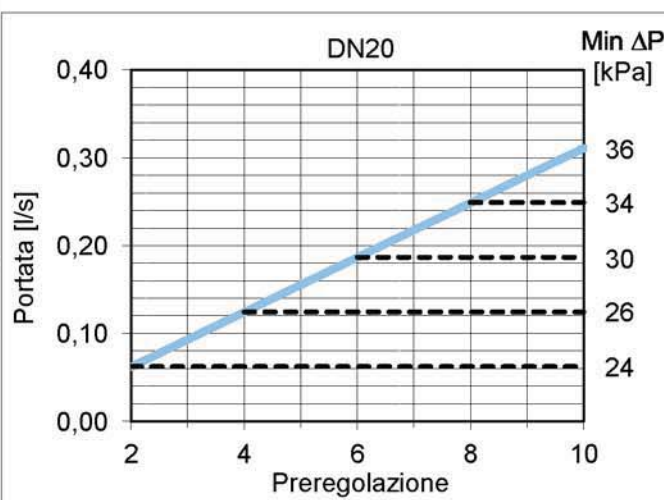

DN20 Prereg.	Portata [l/s]	Portata [l/h]	ΔP min. [kPa]
2	0,062	224	24
3	0,093	336	25
4	0,124	448	26
5	0,156	560	28
6	0,187	672	30
7	0,218	784	32
8	0,249	896	34
9	0,280	1008	35
10	0,311	1120	36

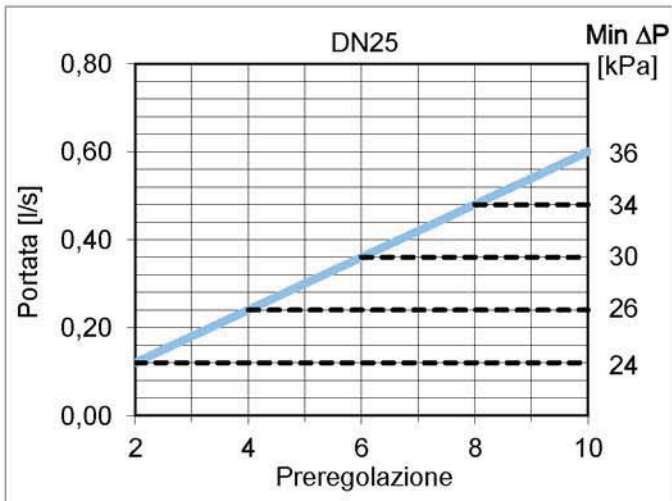

DN25 Prereg.	Portata [l/s]	Portata [l/h]	ΔP min. [kPa]
2	0,120	432	24
3	0,180	648	25
4	0,240	864	26
5	0,300	1080	28
6	0,360	1296	30
7	0,420	1512	32
8	0,480	1728	34
9	0,540	1944	35
10	0,600	2160	36

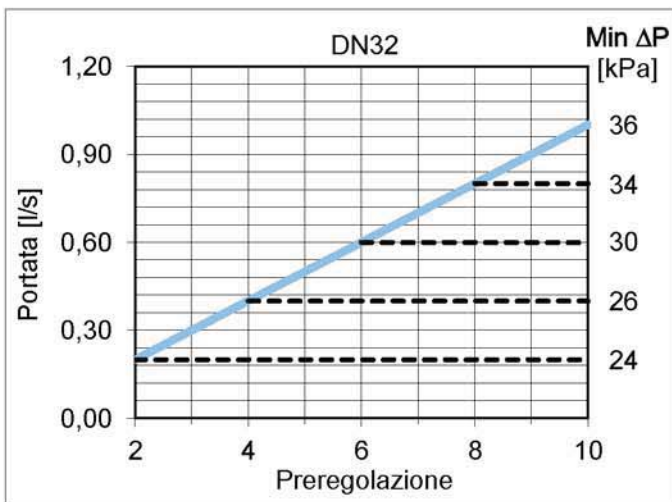

DN32 Prereg.	Portata [l/s]	Portata [l/h]	ΔP min. [kPa]
2	0,200	720	24
3	0,300	1080	25
4	0,400	1440	26
5	0,500	1800	28
6	0,600	2160	30
7	0,700	2520	32
8	0,800	2880	34
9	0,900	3240	35
10	1,000	3600	36



# IVR 327

DZR brass pressure independent control valve (PICV)  
 Threaded M/M for union ends (ISO228/1)  
**With differential pressure regulator for  $\Delta P$  up to 400kPa**  
 Tolerance on nominal regulated flow  $\pm 15\%$   
 Available in the following versions:

- without test points  
 (this does not allow the installation of test points)
- with test points

Flow modulation always use the whole valve stroke  
 (independently from the presetting)

With threaded M30x1,5 connection for linear actuator  
 TR CU 010 compliant

PN20 (Max 20bar up to 100°C, max 10bar at 130°C)  
 Free of CE marking (cat. according to Art. 4.3 Dir. 2014/68/EU)

### Working conditions

- Water: -10°C to +130°C  
 below 0°C only for water with added antifreeze fluids  
 over 100°C only for water with added anti-boiling fluids  
 (Ethylene glycol or propylene glycol mixtures up to 50% may be used)
- Not suitable for: gases group 1 & 2, liquids group 1 (Dir. 2014/68/EU)

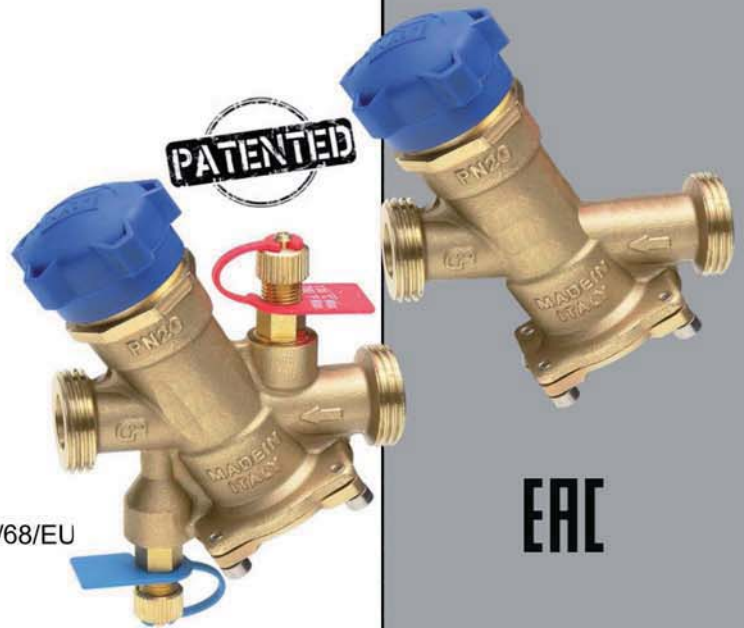

ERC

## PARTLIST

N.	Part	Material	Norm
1	Allen screw	Stainless steel	AISI 304
2	Plug	DZR brass	EN12164 CW602N
3	Cursor <sup>1</sup>	Stainless steel	AISI 303
4	Spring	Stainless steel	AISI 302
5	Cursor seat	DZR brass	EN12164 CW602N
6	Seat/body O-ring	EPDM Perox	-
7	Seat/cursor O-ring	EPDM Perox	-
8	Body	DZR brass	EN12165 CW602N
9	Washer	DZR brass	EN12164 CW602N
10	Disc gasket	EPDM Perox	-
11	Flow reg. group	DZR brass <sup>2</sup>	EN12164 CW602N
12	O-ring	EPDM Perox	-
13	Spring	Stainless steel	AISI 302
14	Graduated scale	Polyamide	-
15	ON/OFF cap	Polyamide	-
16	Test point	DZR brass <sup>3</sup>	EN12164 CW602N

<sup>1</sup>In two pieces, with EPDM Perox diaphragm

<sup>2</sup>With stainless steel spring (AISI 302) and EPDM Perox gaskets

<sup>3</sup>Test points with EPDM gaskets and polypropylene ties

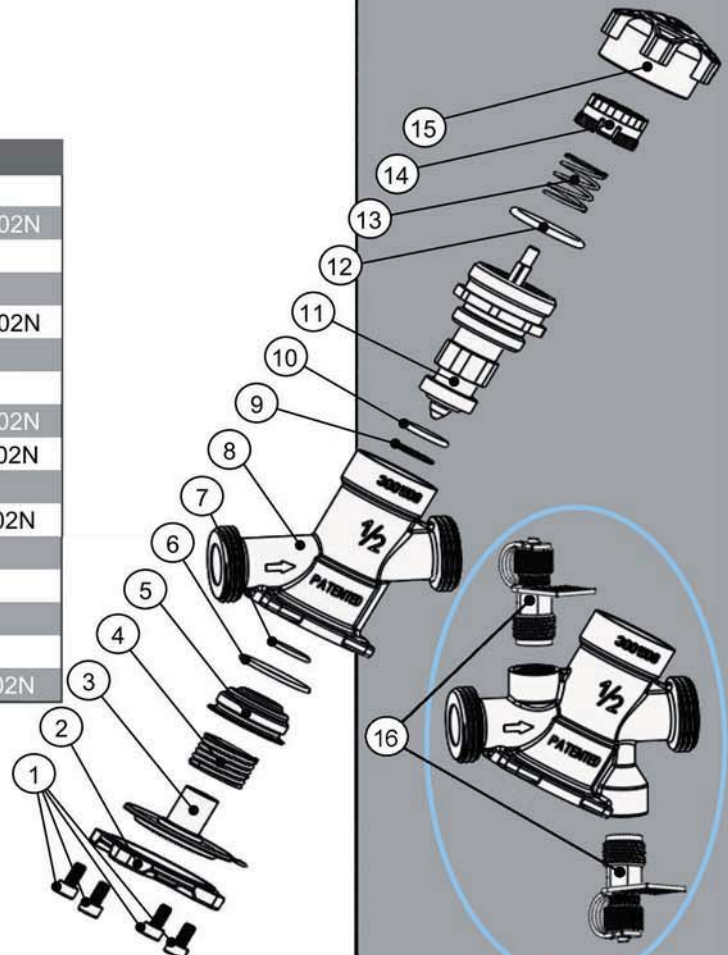



# DIMENSIONS

DN	G	L [mm]	HA [mm]	HP [mm]	HB [mm]	W [mm]	ØV [mm]	Peso <sup>1</sup> [g]	Portate [l/s]
L 015	¾"	78,6	38,9	60,9	62,1	43,0	40	380/420	0,008-0,039
015	¾"	78,6	38,9	60,9	62,1	43,0	40	380/420	0,030-0,150
020	1"	92,0	47,4	69,4	62,0	52,0	40	570/600	0,062-0,311
025	1¼"	115,0	56,2	78,2	75,3	59,4	40	1100/1130	0,120-0,600
032	1½"	140,0	78,0	91,6	76,0	81,5	40	1960/2015	0,200-1,000

<sup>1</sup>Versione senza prese / versione con prese

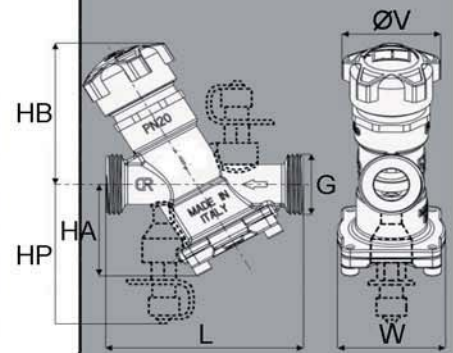

# PRESETTING

Presetting allows to define the maximum flow that will be kept constant (by means of dynamic balancing) while the valve is used in fully open condition in its working differential pressure range.

Presetting determines also the minimum working differential pressure of the valve.

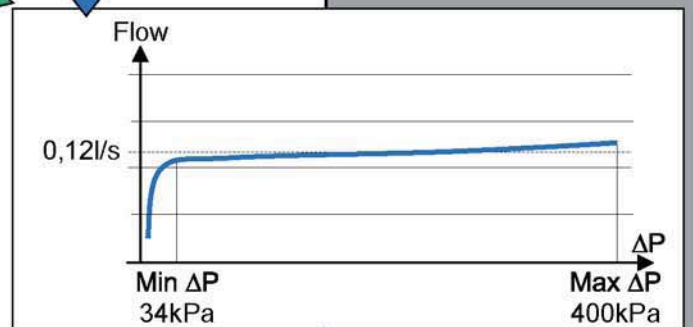
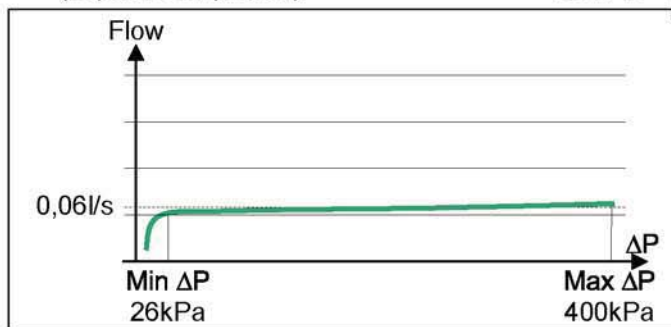
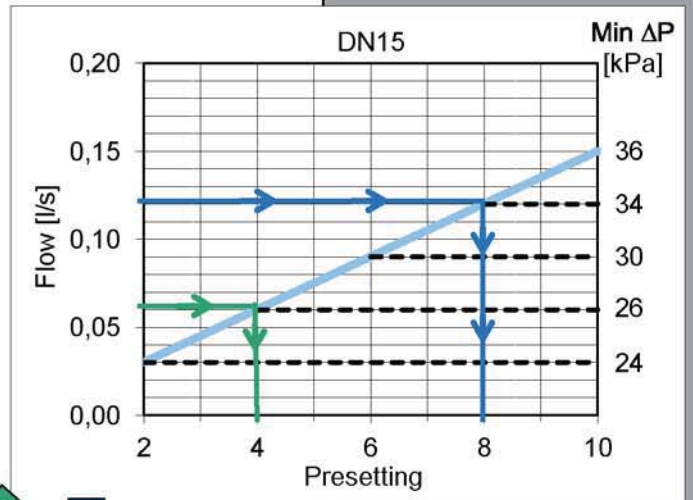
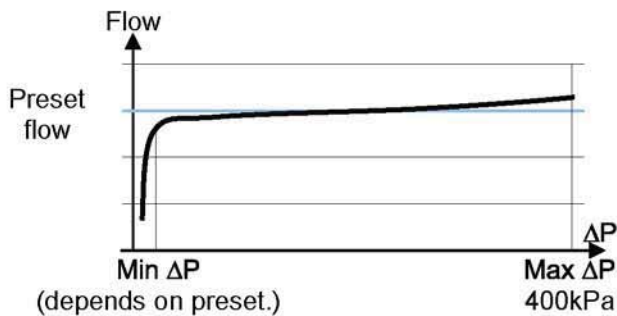

The flow regulating group has the authority on all its full linear stroke. By using a modulating actuator, this allows to maintain proportionality between the control signal and the actual output flow.

In the example, for a maximum flow of 0,12l/s a presetting of 8 is determined on a DN15 valve. The valve will start to operate at a  $\Delta P$  of 34kPa. This flow is then modulated with a 0-10V VIR modulating actuator set as "reverse acting". It's however possible to set the actuator as "direct acting", therefore inverting the correspondence between the flow and the signal (please refer to the technical sheet of the actuator).

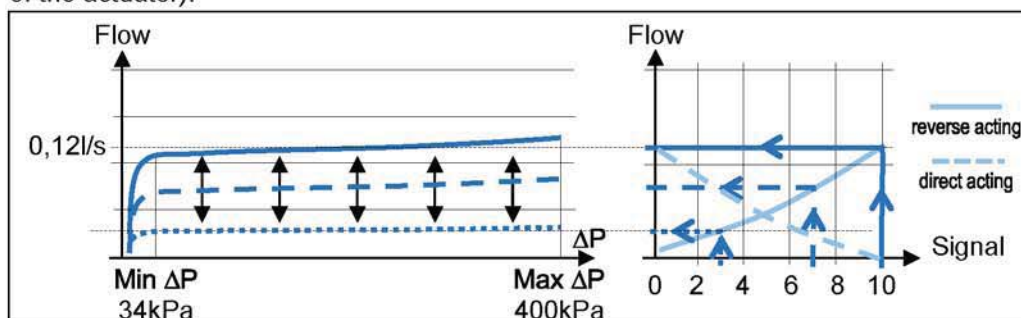

It's possible to preset the valve by operating directly on the graduated scale, without the need for any additional tool:

- push down the graduated scale
- rotate the scale until the desired value aligns with the mark on the bonnet
- release the graduated scale, this will automatically lock in the preset position

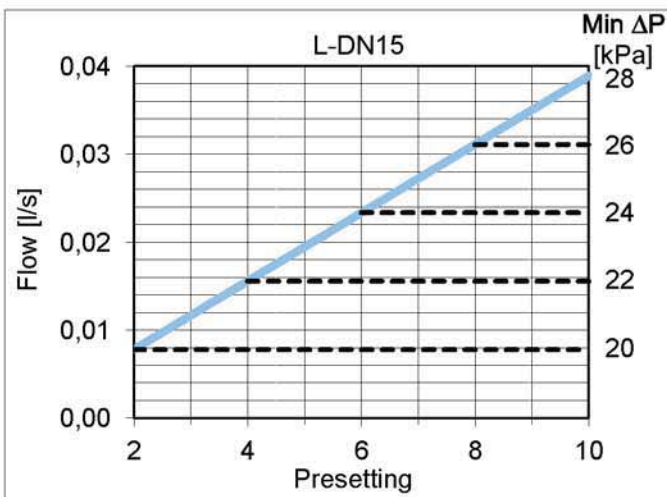

L-DN15 Preset.	Flow [l/s]	Flow [l/h]	ΔP min. [kPa]
2	0,008	28	20
3	0,012	42	21
4	0,016	56	22
5	0,019	70	23
6	0,023	84	24
7	0,027	98	25
8	0,031	112	26
9	0,035	126	27
10	0,039	140	28

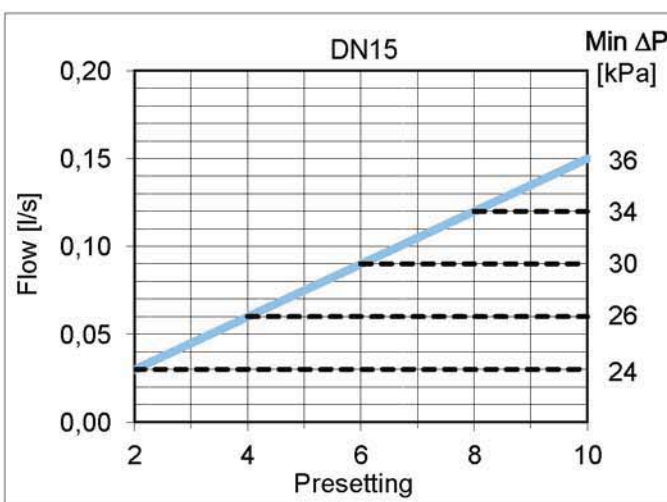

DN15 Preset.	Flow [l/s]	Flow [l/h]	ΔP min. [kPa]
2	0,030	108	24
3	0,045	162	25
4	0,060	216	26
5	0,075	270	28
6	0,090	324	30
7	0,105	378	32
8	0,120	432	34
9	0,135	486	35
10	0,150	540	36

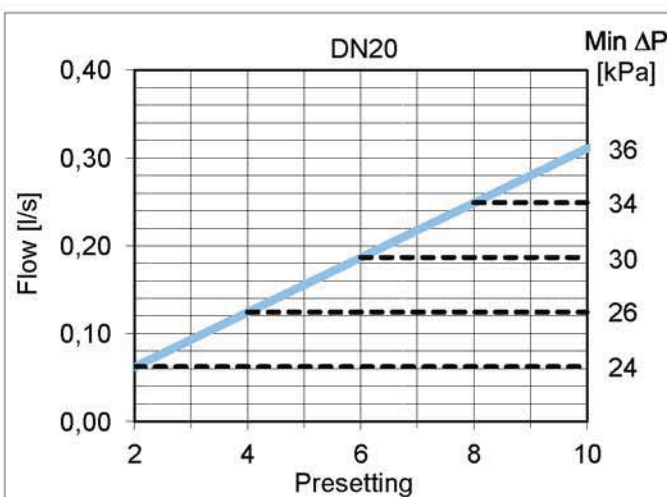

DN20 Preset.	Flow [l/s]	Flow [l/h]	ΔP min. [kPa]
2	0,062	224	24
3	0,093	336	25
4	0,124	448	26
5	0,156	560	28
6	0,187	672	30
7	0,218	784	32
8	0,249	896	34
9	0,280	1008	35
10	0,311	1120	36

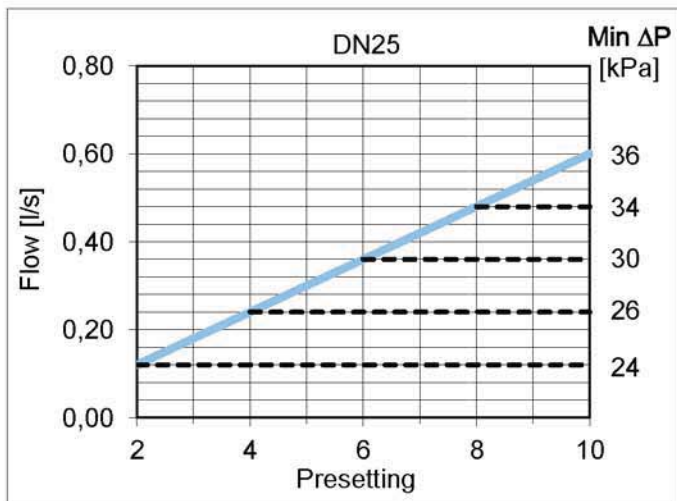

DN25 Preset.	Flow		ΔP min. [kPa]
	[l/s]	[l/h]	
2	0,120	432	24
3	0,180	648	25
4	0,240	864	26
5	0,300	1080	28
6	0,360	1296	30
7	0,420	1512	32
8	0,480	1728	34
9	0,540	1944	35
10	0,600	2160	36

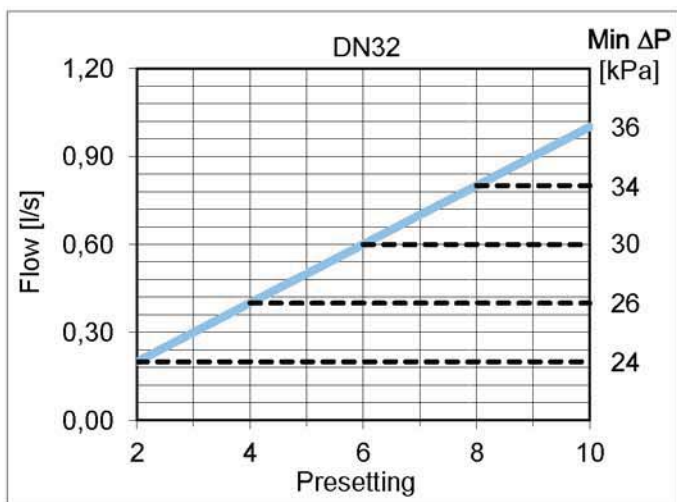

DN32 Preset.	Flow		ΔP min. [kPa]
	[l/s]	[l/h]	
2	0,200	720	24
3	0,300	1080	25
4	0,400	1440	26
5	0,500	1800	28
6	0,600	2160	30
7	0,700	2520	32
8	0,800	2880	34
9	0,900	3240	35
10	1,000	3600	36